

MODEL
VCS-2D-HP



VCS-2D-HP

HIGH POWER STEREO VOLUME CONTROL



INSTALLATION & OPERATION GUIDE

VCS-2D-HP

High Power Stereo
Volume Control

TABLE OF CONTENTS

Introduction	1
Features and Benefits	1
Installation Considerations	3
Installation	8
Operation	10
Specifications	10



Introduction

The VCS-2D-HP is a wall-mount, Decora® style speaker volume control. It connects between the speaker-level output of an amplifier, speaker selector, etc. and a pair of speakers.

A perfect application for the VCS-2D-HP is adjusting the volume of remotely located speakers. The VCS-2D-HP adjusts the volume of speakers connected to it by attenuating the amplifier signal. *Niles volume controls use autoformers instead of L-pads for the volume controlling element. The use of autoformers assures minimal internal power dissipation with virtually no power wasted as heat.*

Features and Benefits

The VCS-2D-HP offers a number of improvements over other volume controls.

- **High Power Handling** – Power handling: 200 watts/channel peak music power. 100 watts per channel continuous.
- **Premium 12 Step Control** – The VCS-2D-HP uses a 12-position control, which is superior to 10-position designs. You get a broader range of adjustment—there are 10 steps

of attenuation instead of 8. Steps 11-6 attenuate -3 dB per step; steps 5-2 are -6 dB per step. Step 12 is “full-on” and step 1 is “full-off.” The VCS-2D-HP delivers “POP-FREE” switching between all steps.

- **Silent When Off** – Niles controls completely silence your speakers when they are at the full-off position
- **Removable Connectors** – The connectors on the VCS-2D-HP are removable and accommodate up to 14 gauge speaker wire. The connectors simplify your installation:
 - The speaker wires are easier to attach—no heavy control to hold onto.
 - The control may be removed without disconnecting any wiring.
 - “Wire-Guard” barriers between each connector terminal reduce the chance of a short-circuit.
- Mounting depth of only 2 9/16”. Fits into standard 18 cu. in. 1-gang electrical boxes.
- Printed circuit board construction uses no hand wiring, assuring high reliability.
- Tested Performance – 100% tested, electronically and acoustically, for frequency response, distortion and power handling.

HIGH POWER STEREO VOLUME CONTROL

TOOLS REQUIRED

- No. 2 Phillips Screwdriver
- 1/8" Standard Slotted Screwdriver
- 1/4" Standard Slotted Screwdriver
- Wire Stripper
- 5/64" Allen Wrench*

- Isolated left and right channel grounds make it safe for use with any amplifier.
- May be used with 4, 6, or 8 ohm speaker systems.
- Ideal for both home and commercial sound installations.
- Available colors: White, Bone, Almond, or Black.
- Proudly made in the USA
- Ten year parts and labor warranty.

Installation Considerations

The VCS-2D-HP is a Decora-style module and is designed to use standard Decora-style faceplates and mounting hardware. Decora faceplates (up to 6-gang) with color-matched plate screws are available from your Niles dealer.

P-Rings and Electrical Boxes

The mounting depth of the VCS-2D-HP is 2 9/16" When installed, the unit extends 2 5/16" behind the sheetrock wall (assuming 1/2" sheetrock). For installation, you must choose between a standard light switch plaster ring (p-ring) or a standard 18 cu. in. (or larger) electrical box. Suitable p-rings and electrical boxes are available from your Niles dealer or local electrical supply company. Using the p-ring is best because it gives you unobstructed access to the full depth

* Only required if changing color of unit.

of the wall. In some instances, the use of a p-ring may be inappropriate, such as in a retro-fit (existing) installation, or when building codes require that wall devices be enclosed in electrical boxes. Contact your local building code and inspection department if unsure.

Type of Speaker Wire

For most applications, we recommend you use 16 or 18 gauge, stranded copper speaker wire for the VCS-2D-HP connections. For wiring runs longer than 80 feet, 14 gauge wire is recommended. Using speaker wire larger than 14 gauge for the VCS-2D-HP connections is not recommended—the wire may not fit into the connectors. Never use solid-core, aluminum, or “Romex” type wire with the VCS-2D-HP. When running speaker wires inside walls, most states and municipalities in the U.S. specify that you must use a special type of speaker wire. Usually, the requirement is that the wire has a specific “CL” fire rating, such as “CL-2” or “CL-3.” Consult your Niles dealer, building contractor, or local building and inspection department if unsure about which type of wire is best for your application.

"Tech Tip"

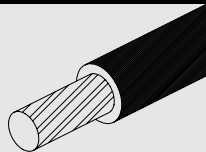

Wire size is expressed by its AWG (American Wire Gauge) number. The lower the AWG number, the larger the wire, i.e., 12 AWG wire is physically larger than 14 AWG.

VCS-2D-HP Mounting Location

Convenient mounting locations for the VCS-2D-HP are:

- Near entryways or exits
- Near a desk
- At your bedside
- Close to a telephone
- Near other wall controls (see caution next page)

DO NOT INSTALL THE VCS-2D-HP INTO ELECTRICAL BOXES WITH 110 VOLT DEVICES

Some states or municipalities allow devices such as the VCS-2D-HP to be installed into the same electrical box as 110 volt devices, provided a “low-voltage partition” is used between the devices. We do not recommend this. Speaker wires can act as an “antenna” for electrical noise. Locating speaker wires too close to a light switch or dimmer may cause a “popping” or “buzzing” sound to be heard through the speakers. If you must locate the VCS-2D-HP near electrical devices, install it in a separate metal electrical box, ground the box to the electrical system ground, and route the speaker wires several feet away from the electrical wiring.

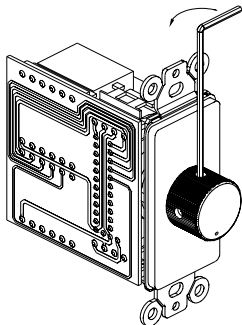

Figure 1
Removing the Knob

Changing the Color of the VCS-2D-HP

The Decora-style insert and knob on the VCS-2D-HP are removable, allowing fast and easy color changes as needed. Inserts and knobs are available in a variety of colors. If you need to change the color of the VCS-2D-HP:

1. Obtain the VCS-2D-HP knob and Decora-style insert in the desired color from your Niles dealer.

2. Holding the VCS-2D-HP control as shown in **(Figure 1)**, make sure that the knob is turned completely counter-clockwise, to the off position. Note the current position of the knob; this will ensure that you install the new knob in the same position as the old one. Next, using a 5/64" allen wrench/driver, locate the two set screws on the side of the knob and carefully loosen both screws until the knob may be removed. It is not necessary to completely remove the screws from the knob.

3. Next, holding the control as shown in **(Figure 2)**, locate the two plastic mounting tabs at the top rear of the Decora-style insert. Using two fingers, simultaneously press both tabs down (towards the center of the insert) and forward (away from you) until the insert pops free from its mounting slots.

4. Locate the new Decora-style insert. Hold the control so that it is facing you. Insert the two bottom tabs into the bottom slots first, followed by the two tabs on the top. Snap the insert into place by carefully pressing on the front of the insert.

5. Locate the new knob. Place the new knob onto the shaft and align it to the same position as the old one. Secure the knob to the shaft by tightening the two set screws on the side of the knob. Holding the VCS-2D-HP as shown in **(Figure 1)**, check the alignment of the knob by turning it through all positions.

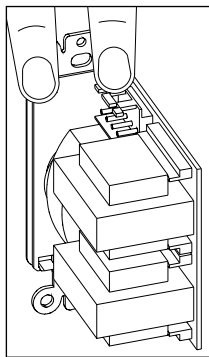
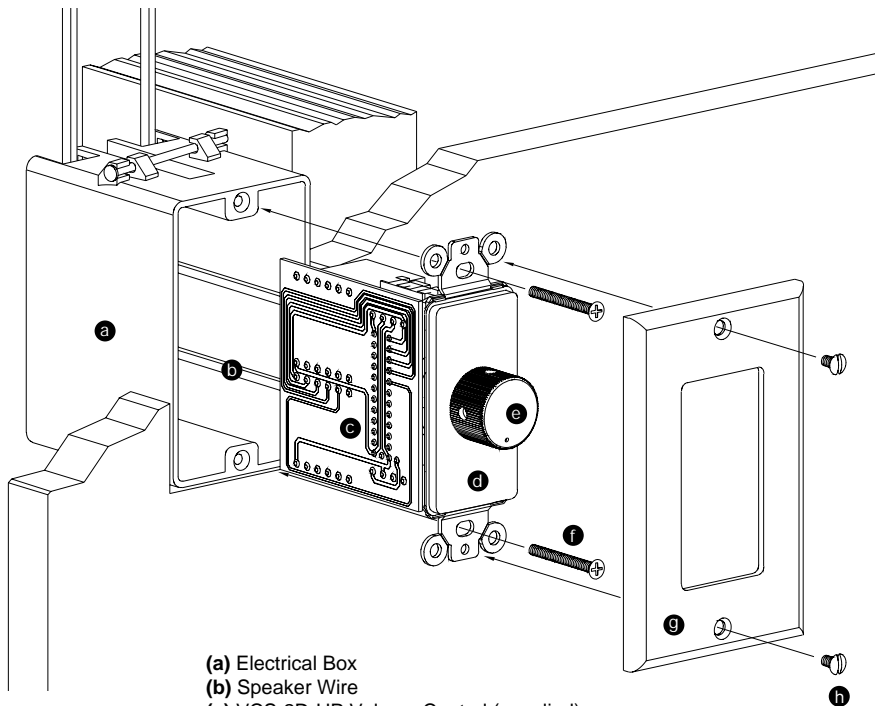

Figure 2
Removing the
Decora-style Insert

"TECH TIP"

Do not exert
excessive pressure on
the plastic
mounting tabs.

HIGH POWER STEREO VOLUME CONTROL



- (a) Electrical Box
- (b) Speaker Wire
- (c) VCS-2D-HP Volume Control (supplied)
- (d) Snap-on Color Insert (supplied)
- (e) Knob (supplied)
- (f) Device Screws (2 supplied)
- (g) Decora Wallplate (supplied)
- (h) Faceplate Screws (2 supplied)

Installation

If you are installing the VCS-2D-HP into an existing wall, take time to consider any possible obstructions which may be hidden inside the wall, such as wood and metal studs; electrical, telephone or other types of wiring; plumbing; conduit; old wall safes; etc.

1. Install the electrical box or p-ring in the usual manner.
2. Run all the necessary wiring to the VCS-2D-HP. Label the wires for future reference.
3. Make the connections to the VCS-2D-HP. Locate the connectors for the VCS-2D-HP (remove them if they are plugged in). Next, strip 1/4" of insulation from the end of each wire. Tightly twist the end of each wire until there are no frayed ends. Insert each wire into the appropriate hole on the removable connector blocks; secure the wiring to the connectors by tightening the small connector screws. Be certain that proper phasing is observed—connect the positive terminals on the VCS-2D-HP to the positive terminals on the amplifier and speakers; the negative terminals on the VCS-2D-HP to the negative terminals on the amplifier and speakers. See (Figures 3 and 4).

The inputs of the VCS-2D-HP are the connector pins labeled "AMPLIFIER." The outputs are the connector pins labeled "SPEAKERS." Be sure not to reverse these connections or the VCS-2D-HP will not function properly.

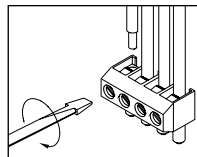

Figure 3
Wiring the Connectors

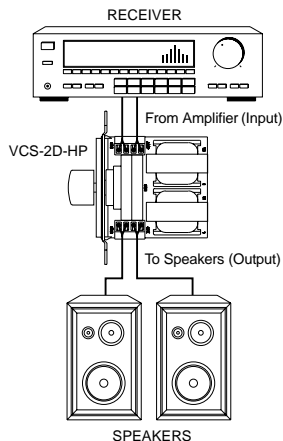

Figure 4
Wiring Diagram

HIGH POWER STEREO VOLUME CONTROL

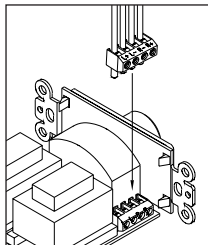

Figure 5
Installing the
Connectors

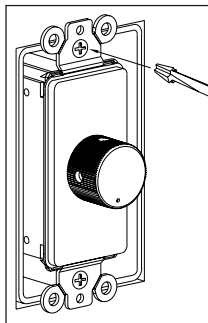

Figure 6
Loosening the Screws
for a Flush Fit

4. Plug the connectors into the VCS-2D-HP as shown in (Figure 5)

5. Secure the VCS-2D-HP to the electrical box or p-ring. Insert the 1/4" long device screws into the oblong-shaped screw holes on the top and bottom of the VCS-2D-HP. Note that the oblong shape of the screw holes allow you to position the VCS-2D-HP so that it is vertical. Position the VCS-2D-HP so that the screws are aligned with the threaded holes in the electrical box or p-ring. Tighten the screws using a phillips screwdriver. **DO NOT OVER-TIGHTEN.** In some instances, you may need to loosen these screws several turns to allow the VCS-2D-HP to fit flush with the Decora cover plate. See (Figure 6).

6. Use the shorter plate screws to fasten the Decora faceplate to the VCS-2D-HP. **DO NOT OVER-TIGHTEN THE PLATE SCREWS OR YOU MAY DAMAGE THE FACEPLATE.** Line up all the screws in the same direction for a finished look. NOTE: Certain "old work" or "retro-fit" boxes, such as the Carlon B225R, have a plastic "lip" which interferes with the Decora faceplate screws. This lip prevents you from being able to tighten these screws completely. To make the clearance necessary for these screws, you must remove the parts of the lip causing the interference. There are two ways to accomplish this:

1. Drill through the lip of the box at the screw points.
2. Cut notches into the lip with a pair of diagonal cutters.

Operation

1. Make sure the amplifier or receiver power is OFF and set the volume to minimum.
2. Set the VCS-2D-HP volume to maximum (fully clockwise).
3. If you are using a Niles speaker selection system, locate the ON/OFF button which corresponds to the speaker pair you wish to play. Set it to the ON position.
4. Turn on the amplifier or receiver and select a source, such as the tuner or CD player.
5. Slowly turn up the amplifier or receiver volume and set it to a comfortable (not maximum) listening level. Be careful not to overdrive or "clip" your amplifier. If the sound becomes muddy or distorted, you have reached the limit of your amplifier's volume capability and should quickly reduce the volume to avoid damaging your speakers.
6. Adjust the volume of the speakers to the desired listening level using the VCS-2D-HP. If all the speaker pairs in your system are equipped with Niles volume controls, you can leave the amplifier or receiver volume set at one position and use the Niles controls exclusively.
7. You can turn off the speakers by turning the knob on the VCS-2D-HP fully counter-clockwise, or by pressing the ON/OFF button on your speaker selector.

SPECIFICATIONS

Audio Power Handling

200 Watts/channel
peak music power
100 Watts/channel
continuous power

Mounting

In-wall, fits into most
18 cu. inch single-
gang electrical boxes
at least 2 3/4" deep,
Decora-style faceplate

Wiring Requirements

Individual runs of
2-conductor speaker
wire, 14-22 gauge

Unit Dimensions

1 5/8" wide x 2 5/8"
high

Face Plate Dimensions

Decora wall plate;
2 3/4" wide x 4 1/2"
high

Depth Behind Plate

2 9/16"



Niles Audio
Corporation

www.nilesaudio.com

12331 S.W. 130 Street
Miami, Florida, 33186
Tel: (305) 238-4373
Fax: (305) 238-0185

© 1999 Niles Audio Corporation. Niles and the Niles logo are registered trademarks of Niles Audio Corporation. Decora® is a registered trademark of Leviton Manufacturing Company. DS00134A