

IntelliPad®



IntelliPad®

WALL MOUNTED PROGRAMMABLE IR KEYPAD SYSTEM



INSTALLATION & OPERATION GUIDE

**IntelliPad®**  
 Wall Mounted  
 Programmable IR  
 Keypad System

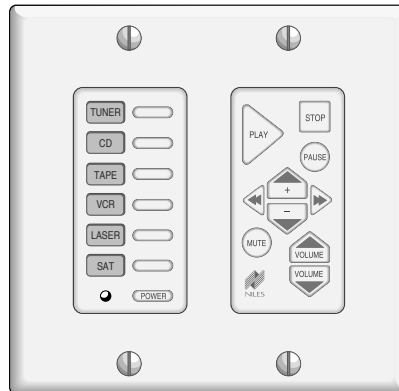
TABLE OF CONTENTS

Introduction 1  
 Features and Benefits 2  
 Parts Guide 4  
 Installation Considerations 6  
 Installation 11  
 Programming Considerations 15  
 Programming 17  
 Operation 26  
 Troubleshooting 28  
 Specifications 29



**Introduction**

Introducing IntelliPad®, the world's first wall-mounted, programmable IR keypad system that provides a unique LED power status display and the convenience of true one-button remote control of complex audio/video systems.



**Figure 1**  
 The IntelliPad

## Features and Benefits

---

### **Power Status Display and Synchronization**

The Status Feedback feature eliminates the guesswork common with other IR control systems. The power LED indicates the On/Off condition of the system's preamp/receiver. Built-in intelligence tracks this (On/Off condition of the preamp/receiver) so the IntelliPad knows when it's appropriate to issue the power command. The system maintains perfect synchronization between the amplifier and the user.

### **One-Button Macros With Power Synchronization**

Located on the left hand side of the keypad are six Source Select keys, each with its own corresponding backlit label. When you press a Source Select key, a synchronized sequence of IR commands is initiated. It's synchronized, because the internal microprocessor first checks if the preamp/receiver is on or off. The keypad only issues the "power" command if the preamp/receiver is off. After it has verified that the preamp/receiver is on, it proceeds with the necessary commands to select the correct input, type of surround sound or equalization, and the play or favorite station command for the source component.

### **Speaker Relay**

The IntelliPad incorporates a unique speaker muting function with status display. When you press the Mute key the local speakers turn off and the status LED turns from green to red (green means the speakers are on, red means the speakers are off). In a multi-room system, when a user in one of the rooms turns on the system, only that room's speakers turn on. All other rooms display that the system is on, but muted locally. In another room, you simply press the "Mute" button to turn on the local speakers.

### **Multiple "Pages" of Function Control Keys**

Once you have pressed one of the six Source Select keys (CD, tuner, tape etc), the Function Control keys, located on the right-hand side of the keypad, operate the selected source (play, stop, pause, next station, seek, etc). When another Source Select key is pressed, the right hand keys operate the newly selected source. With this system of multiple "pages" of IR commands just a few, ergonomically shaped buttons will issue the dozens of infrared commands needed in a typical audio/video system.

## WALL MOUNTED PROGRAMMABLE IR KEYPAD SYSTEM

### **Press and Hold Commands**

The IntelliPad can differentiate between a normal press of a key, and a “press and hold” of a key (a press which lasts for more than one second). This Press and Hold feature enables the six Source Select keys and the Power key to be programmed for up to two functions.

### **Pre-printed Source Labels**

The backlit labels allow you to customize the keypad to any system with the supplied pre-printed translucent labels. Labels include standard audio/video components and IR controllable devices, as well as some common and uncommon names for macro functions.

### **Quick and Easy Programming**

The IntelliPad makes installation fast and simple. Programming is made easy via programming push-buttons and LEDs which provide visual prompts—leading you step-by-step through the programming process.

### **Program Duplication**

The memory contents of a programmed keypad can be transferred directly into another keypad via a supplied cable—thereby simplifying the programming of multiple keypads within a single system. Additionally, it is possible to archive and transfer the IntelliPad’s programmed memory using a personal computer with the optional Windows® based IntelliFile® PC Storage and Transfer System.

### **Integrates With IR Sensors**

In an IR repeater system, any IntelliPad may have an IR sensor connected to it (See page 10, Figure 6). Hand-held remote controls may be used in any room equipped with an IR sensor.

### **Retrofittable for Easy Upgrades**

IntelliPad utilizes the same two-conductor shielded cable as an infrared repeater system—making it the perfect upgrade solution.

### **Memory Protection**

Each keypad is protected against accidental loss of program memory by a ten-year backup battery.

### **Instant Color Changes**

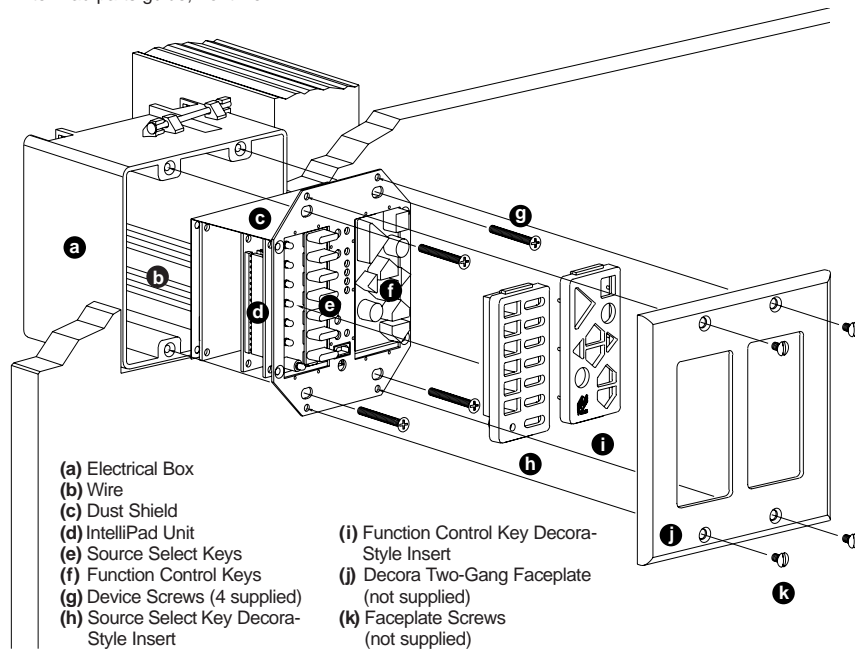
Removable Decora® style color inserts make on-site color changes a snap. Both bone and white colors are included with your IntelliPad.

### **Proudly Made in USA**

The IntelliPad is made in the USA and comes with a limited two year parts and labor warranty.

WALL MOUNTED PROGRAMMABLE IR KEYPAD SYSTEM

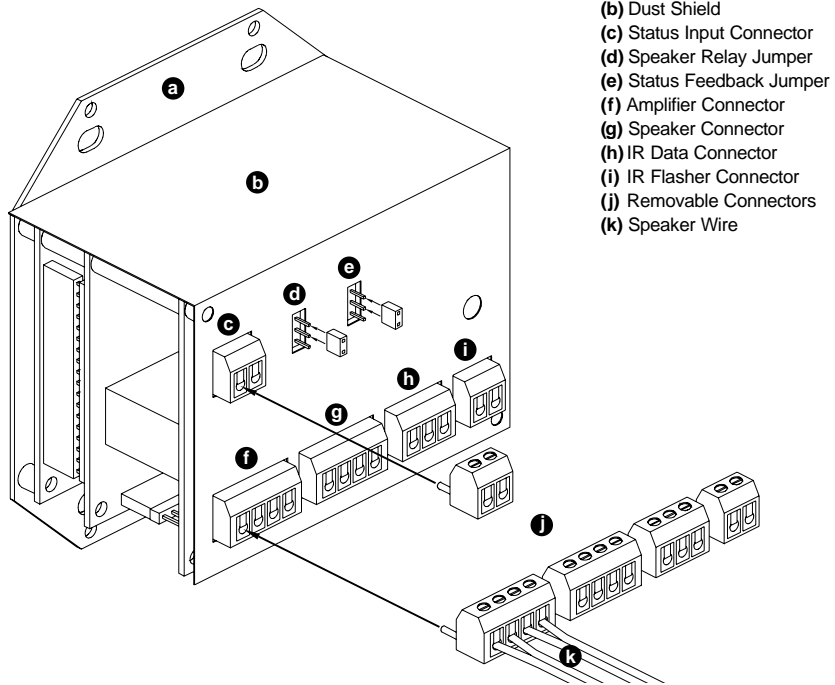
**Figure 2**  
IntelliPad parts guide; front view



Note: The above figure illustrates how the IntelliPad would be installed by itself. However, because of its modular Decora-style design, the IntelliPad can be combined in a three or four-gang configuration with additional wall-mount control devices.

WALL MOUNTED PROGRAMMABLE IR KEYPAD SYSTEM

**Figure 3**  
IntelliPad parts guide; rear view



## Installation Considerations

---

### IntelliPad Mounting Location

Convenient mounting locations for the IntelliPad include:

- Near entryways or exits
- Near a desk
- At your bedside
- Close to a telephone
- Near other wall controls

**CAUTION:** DO NOT INSTALL THE INTELLIPAD INTO ELECTRICAL BOXES WITH 110 VOLT DEVICES

Some states or municipalities allow devices such as the IntelliPad to be installed into the same electrical box as 110 volt devices, provided a "low-voltage partition" is used between the devices. We do not recommend this. Speaker wires can act as an "antenna" for electrical noise. Locating speaker wires too close to a light switch or dimmer may cause a "popping" or "buzzing" sound to be heard through the speakers. If you must locate the IntelliPad near electrical devices, install it in a separate metal electrical box, ground the box to the electrical system ground, and route the speaker wires several feet away from the electrical wiring.

### Concealing the Cable

If you have doubts about whether you are capable of concealing wires in your walls, consult a Niles dealer or professional installer. They have special tools, techniques, and experience to make the impossible possible. The installer can provide you with an estimate before any work is done.

### P-Rings and Electrical Boxes

The mounting depth of the IntelliPad is 2 1/2". When installed, the unit extends 2" behind the sheetrock wall (assuming 1/2" sheetrock). For installation, you must choose between a two-gang standard light switch plaster ring (p-ring) or a two-gang standard 36 cubic in. (or larger) electrical box. Suitable p-rings and electrical boxes are available from your Niles dealer or local electrical supply company. Using the p-ring is best because it gives you unobstructed access to the full depth of the wall. In some instances, the use of a p-ring may be inappropriate, such as in a retro-fit (existing) installation, or when building codes require that wall devices be enclosed in electrical boxes. Contact your local building code and inspection department if unsure.

**Connecting the IntelliPad to a Niles IR repeater system capable of broadcasting a status feedback signal**

Normally, from every IntelliPad location you must "home-run" an IR data cable back to the IR main system unit (models IRP2+, IRP6+, IRZ6+). Home run means an individual cable is connected between each IntelliPad and the IR main system unit.

The IntelliPad connects to the IR main system unit with 2-conductor shielded cable. Recommended cables are "Data Grade" cables made of two 22 gauge (or larger) conductors surrounded by a foil shield and a bare drain (ground) wire. Data Grade Cable provides the capability for runs of up to 500 feet to each IntelliPad. Examples are West Penn D291, Belden 8761 or Carol C2516. Non-data grade 22-16 gauge 2-conductor shielded cable will enable 150 foot runs to each IntelliPad, and are available at your local hardware store.

The IR main system unit will supply power and status feedback to the IntelliPad and will output the IR commands to your components via flashers attached to the IR main system unit. See **Figure 4**.

If you intend to use the IntelliPad's Speaker Relay feature you must run the speaker wire from the amplifier to the IntelliPad and from the IntelliPad to the speakers. See **Figure 4**.

**Connecting an IntelliPad in a "Stand Alone" system using a direct status feedback connection**

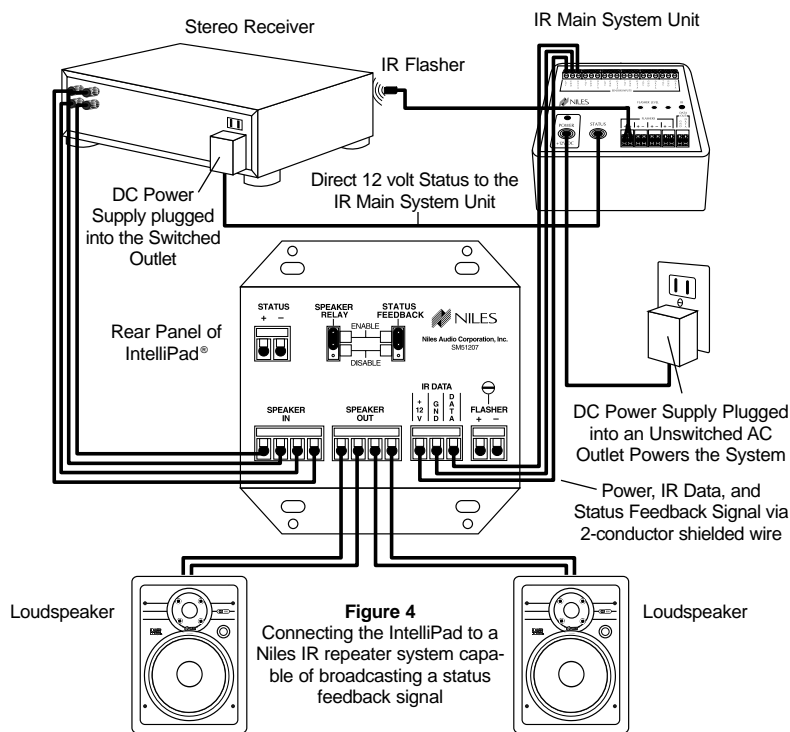
Power is supplied via a 12v DC wall adapter of at least 200mA. You may extend the wall adapter's cable up to 200' with 2-conductor 16 gauge wire to connect to the 12v+ and the GND terminals on the **IR DATA** connector of the IntelliPad. See **Figure 5**.

Your IR controllable A/V components are controlled via the flasher connector (accommodates up to four series connected flashers). You may extend the IR flasher wires up to 200 feet with 2-conductor 16-gauge wire (shielding is not usually necessary).

If you intend to use Status Feedback you must plug a 12v DC wall adapter into the switched outlet of the preamp/receiver and connect the outputs to the + and - terminals on the status connector. You may extend the wall adapter's cable up to 200' with 2-conductor 16 gauge wire (shielding is not desirable or necessary).

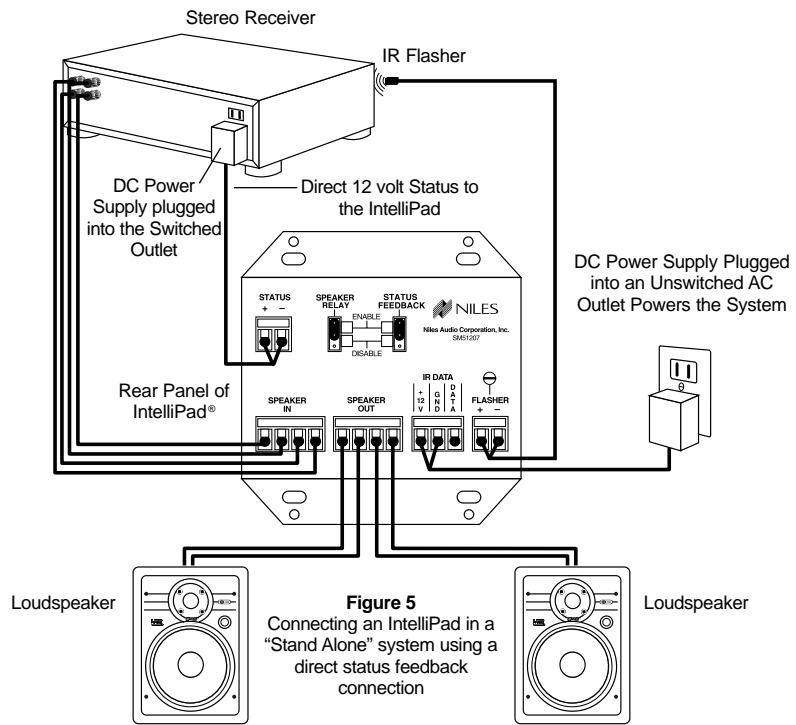
If you intend to use the IntelliPad's speaker relay, you must run the speaker wire from the amplifier to the IntelliPad and from the IntelliPad to the speakers. See **Figure 5**.

WALL MOUNTED PROGRAMMABLE IR KEYPAD SYSTEM



**Figure 4**  
Connecting the IntelliPad to a Niles IR repeater system capable of broadcasting a status feedback signal

WALL MOUNTED PROGRAMMABLE IR KEYPAD SYSTEM



## WALL MOUNTED PROGRAMMABLE IR KEYPAD SYSTEM

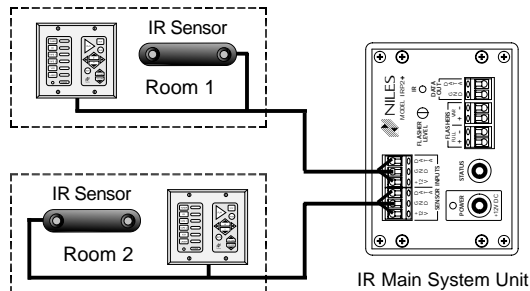
### Speaker Cable

For most applications, we recommend you use 16 or 18 gauge, stranded copper speaker wire for the IntelliPad Speaker Relay connections. For wiring runs longer than 80 feet, 14 gauge wire is recommended. Using speaker wire larger than 14 gauge for the IntelliPad connections is not recommended—the wire may not fit into the connectors. Never use solid-core, aluminum, or “Romex” type wire with the IntelliPad. When running speaker wires inside walls, most states and municipalities in the U.S. specify that you must use a special type of speaker wire. Usually, the requirement is that the wire has a specific “CL” fire rating, such as “CL-2” or “CL-3.” Consult your Niles dealer, building contractor, or local building and inspection department if unsure about which type of wire is best for your application.

### Combining a Sensor with an IntelliPad in the Same Room

There is an exception to the “home run” wiring rule when you are placing both a keypad and a sensor in one room. Only in this case may you “daisy-chain” a single cable. A cable is run between the keypad and the IR sensor and a single cable is run from either the IR sensor or the keypad back to the IR main system unit. Only ONE IR sensor and ONE keypad can be combined on ONE cable. NEVER daisy-chain two IR sensors. See **Figure 6**.

**Figure 6**  
IR sensor cable is “daisy-chained” from an IR Sensor to an IntelliPad and then back to the IR Main System Unit. NEVER “daisy-chain” two IR sensors.



## Installation

### Overview

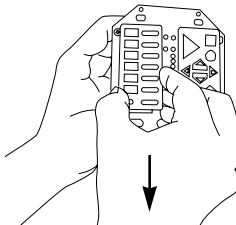
The IntelliPad is installed by following these steps in order:

1. Install the electrical box (J-box) or plaster ring (P-ring) in the usual manner.
2. Run the cables to the IntelliPad location. Label all cables. See *Installation Considerations*.
3. Install the Source Labels.
4. Set the Status Feedback and Speaker Relay jumpers to the correct configuration. (See page 12).
5. Make the connections to the IntelliPad.
6. Secure the IntelliPad to the J-box or P-ring.
7. With power off, make the connections to the IR main system unit and IR flasher. Then connect the power and status feedback wall adapters.
8. Program the IntelliPad. You can choose from three programming options:
  1. Manual programming
  2. Memory transfer from a preprogrammed IntelliPad
  3. Memory transfer from a personal computer using the Niles IntelliFile PC Transfer and Storage System.
9. Secure the Decora faceplate to the IntelliPad.

### Installing the Source Labels

Included with the IntelliPad is a sheet of precut and preprinted labels for your convenience. To install the labels follow these steps:

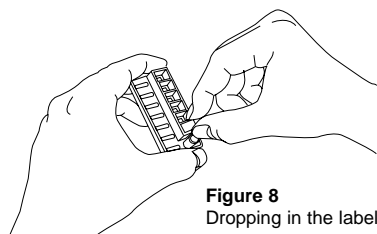
1. Holding the IntelliPad as shown in **Figure 7**, remove the white Decora style inserts on the face of the IntelliPad by pulling straight back away from the IntelliPad. The inserts are held in by friction fit pegs and pop free very easily.



**Figure 7**  
Removing the  
Decora inserts

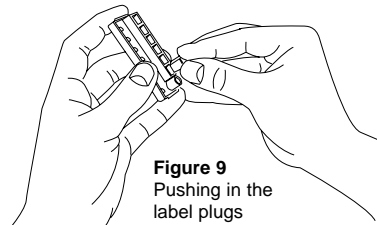
2. Before installing labels determine which color (bone or white) Decora-style insert is appropriate for your installation and reserve them in a convenient place.
3. Detach labels you would like to use. Reserve them in a convenient place.
4. Remove the six plastic label plugs from their bag and place them next to the labels.

## WALL MOUNTED PROGRAMMABLE IR KEYPAD SYSTEM

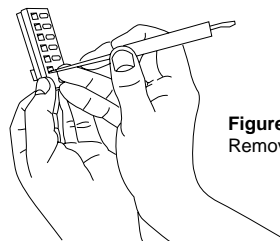


**Figure 8**  
Dropping in the labels

5. While holding the Decora insert with the label holders upside down, drop each of the labels into the correct label holder. See **Figure 8**.
6. The label plugs are wedge shaped. Insert the narrow end of the plug into the label holder and press down until the label plug is flush with the rear of the label holder. This locks the label into place. See **Figure 9**.
7. Once all of the labels are locked in place, take a look at the labels. If they are in the correct order, right side up and otherwise satisfactory,



**Figure 9**  
Pushing in the  
label plugs



**Figure 10**  
Removing a label

- you may proceed. However, if you need to correct one of the labels, use a small screwdriver to gently push the label and label plug back out of the cavity. See **Figure 10**.
8. Install the correctly labeled Decora insert by holding the control so that it is facing you. Fit the insert around the keys of the IntelliPad. Align the pegs on the back of the insert with the corresponding holes on the steel bracket of the IntelliPad. Fix the insert into place by carefully pressing on the front of the insert. The pegs friction fit into the holes and hold the inserts in place.

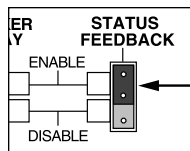
### Configuring The IntelliPad Jumpers

Different jumper settings change operation in the following ways:

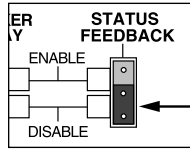
#### Status Feedback Jumper

Use the ENABLE setting if you are giving the IntelliPad Status Feedback via the Status input on the IntelliPad or via a Niles IR main system unit.

WALL MOUNTED PROGRAMMABLE IR KEYPAD SYSTEM



**Figure 11**  
Jumper setting for ENABLING the Status Feedback feature



**Figure 12**  
Jumper setting for DISABLING the Status Feedback feature

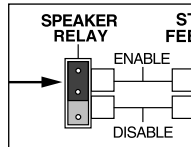
When status feedback is enabled the IntelliPad will automatically issue the preamp/receiver's power command when a Source Select key is pressed and the preamp/receiver is off (this is the auto power insert feature). The status LED and the selected source label are only lit when the preamp/receiver is on. See **Figure 11**.

Use the DISABLE setting if you are unable to provide any Status Feedback to the IntelliPad. When Status Feedback is disabled the IntelliPad will no longer automatically insert the preamp/receiver power command when a Source Select key is pressed; also the status LED and the source labels will only light for 16 seconds after any IntelliPad key is pressed, regardless of whether the preamp/receiver is on or off. See **Figure 12**.

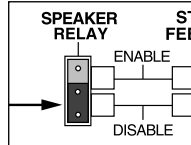
Speaker Relay Jumper

Use the ENABLE setting if you are running the speaker wire through the IntelliPad's speaker relay. If the Mute key is pressed when the system is in use, the IntelliPad's internal speaker relay will mute the speakers in that room only. The Status LED will change from green to red. In a system with multiple IntelliPads, when someone turns on the system from an IntelliPad, the speakers only play in that room. All other IntelliPads will indicate that the system is in use by lighting the Status LED red and will stay muted until someone touches either the Mute key or one of the six Source Select keys in that room. See **Figure 13**.

Use the DISABLE setting if you are unable to run your speaker wires to the IntelliPad. You may elect to program an IR command into the Mute key. See **Figure 14**.



**Figure 13**  
Jumper setting for ENABLING the Speaker Relay feature



**Figure 14**  
Jumper setting for DISABLING the Speaker Relay feature

## WALL MOUNTED PROGRAMMABLE IR KEYPAD SYSTEM

### Connections at the IntelliPad

All of the connections are made via removable screw-type connectors which are included with the IntelliPad. First, strip 1/4" of insulation from the end of each wire. Tightly twist the end of each wire until there are no frayed ends. Insert each wire into the appropriate hole on the removable connector block; secure the wiring to the connector by tightening the small connector screws. Double-check all connections. Plug the connector into its socket on the IntelliPad.

Repeat this process with each of the connectors you will be using in your system. Follow the connection polarity and channel markings silk-screened to the back of the IntelliPad.

### Securing the IntelliPad to the Electrical Box or P-Ring

Insert the 1 1/4" long device screws into the oblong-shaped screw holes on the top and bottom of the IntelliPad. Note that the oblong shape of the screw holes allow you to position the IntelliPad so that it is vertical. Position the IntelliPad so that the screws are aligned with the threaded holes in the electrical box or p-ring. Tighten the screws using a phillips screwdriver. **DO NOT OVER-TIGHTEN.** In some instances, you may need to loosen these screws several turns to allow the IntelliPad to fit flush with the Decora cover plate.

### Connecting to the IR Main System Unit

Strip 1/4" of insulation from the end of each wire. Tightly twist the end of each wire until there are no frayed ends. Insert the end of each wire into the appropriate hole on the IR main system unit's connector block; secure the wiring to the connector by tightening the small connector screws. Double-check all connections. This manual contains instructions for the IntelliPad only. For specific information on the adjustment of your Niles Infrared system, please refer to the instruction manual included with your Niles IR Main System Unit.

### Installing the Decora Cover Plate

Use the shorter plate screws (included with the Decora style cover plates) to fasten the Decora cover plate to the IntelliPad. **DO NOT OVER-TIGHTEN THE PLATE SCREWS OR YOU MAY DAMAGE THE COVER PLATE.** Line up all the screws in the same direction for a finished look.

NOTE: Certain "old work" or "retro-fit" boxes, such as the Carlon B225R, have a plastic "lip" which interferes with the Decora plate screws. This lip prevents you from being able to tighten these screws completely. To make the clearance necessary for these screws, you must remove the parts of the lip causing the interference. There are two ways to accomplish this:

1. Drill through the lip of the box at the screw points.
2. Cut notches into the lip with a pair of diagonal cutters.

## Programming Considerations

### Page and Key — The Memory Address for Every IR Code and Sequence

Every command you want the IntelliPad to issue must be stored and given a memory address. This address is composed of two parts, the “Page” and the “Key”. The Key is the actual key you would press on the IntelliPad. The Page describes one of eight different layers of memory storage.

The six Source Select keys decide which “page” of IR command memory will be accessed when one of the of Source Select keys is pressed. That way, the same key can issue a VCR play command when the VCR is selected as a source and will issue a CD play command when the CD is selected as the source.

### System Page

All of the IR commands for the main system pre-amp/receiver are stored on a hidden seventh page of IR command memory. This page is called the System Page because it controls the entire system. It is also the default page. When you press the Volume Up key, the IntelliPad will look for a code stored in the particular source page (e.g. a local TV set). However, if there is no code, the IntelliPad defaults to the preamp/receiver Volume Up code stored on the System Page. That way, you only have to program the Volume Up and Volume Down codes on the System Page.

Normally, while on the System Page the six Source Select keys store the preamp/receiver input commands, the Power key stores the power command, and the Volume Up and Volume Down keys store the volume commands. The remaining keys can be used to store IR commands which are only used in sequences (e.g. Stereo/Surround Modes, EQ settings, Numeric Keys).

### Sequences Take Priority

A sequence can be triggered by any key except the Power key. A sequence takes priority over an IR command stored on the same key and page. In this case, the IntelliPad will only issue the sequence, not the IR command.

When you program a sequence to be triggered by a particular key, you may include any IR command stored there, but you do not have to. That IR command could be used in some other sequence.

**NOTE:** Since the System Page is the default page, any IR command stored on the System Page using the Function Control keys (i.e. Play, Stop, Pause etc.) can be accidentally issued by the user.

This occurs when the key is pressed on a Source Page which has no IR code stored at that key address. You can prevent this default action from occurring by inserting a sequence that consists of

WALL MOUNTED PROGRAMMABLE IR KEYPAD SYSTEM

only one step (1/2 second delay) at the unused key address — the sequence takes priority over the empty key address which prevents the IntelliPad from defaulting to the System page.

**Press and Hold Page**

The six Source Select keys and the Power key

can be programmed to have up to two functions. The second function can be accessed by pressing and holding one of these keys for more than one second. These special commands or sequences are stored on an eighth page of IR command memory, the Press and Hold page.

The IR/SEQ Button enables you to toggle between programming single IR commands and programming sequences. The IR/SEQ LED displays which mode was selected.

The PROGRAM button begins and ends all programming. The PROGRAM LED displays when you are in "programming mode".

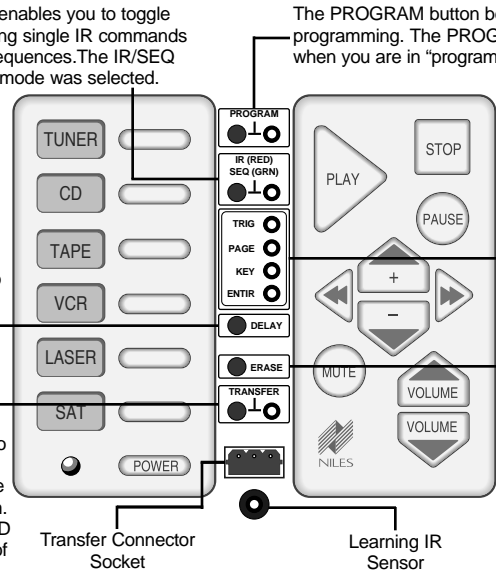
**Figure 15**  
Programming Controls and LEDs

The DELAY Button enables time delays of .5 - 16 seconds to be programmed into sequences

The TRANSFER Button enables the transfer of memory from one keypad to another keypad, or to a PC using the IntelliFile PC Storage and Transfer System. The TRANSFER LED display the transfer of memory.

The Prompting LEDs indicate the next programming step.

The ERASE Button enables you to erase a single IR command, a complete sequence, or the entire memory



## Programming

---

### Overview

The IntelliPad system is programmed in six fundamental stages:

1. Teach all of the preamp/receiver IR commands onto the System page.
2. Teach each of the source component IR commands onto the Source Pages.
3. Teach a secondary IR command onto the Press and Hold Page.
4. Configure sequences of preprogrammed IR commands and/or delays to trigger from any or all keys (except the Power key) on all pages (including the Press and Hold page).
5. Permanently archive the program you have created on a PC using the optional IntelliFile PC Transfer and Storage System.
6. Transfer the program to any additional IntelliPads in the system.

### Ground Rules and Guidelines

#### Erasing the Entire Memory Before You Start

Before beginning to program the IntelliPad, erase any earlier programs by following these steps:

1. *Press the PROGRAM button.* The PROGRAM LED, the IR/SEQ LED and the PAGE LED light up red.
2. *Press and hold the ERASE button until all the Prompt LEDs flash, then release.* The PROGRAM LED begins to flash, warning you that you are about to erase.
3. *Press and hold the ERASE button until all the Prompt LEDs flash.* This erases the entire memory of the IntelliPad.
4. *To exit the Program mode, press the PROGRAM button once.*

### Teaching IR—The Basics

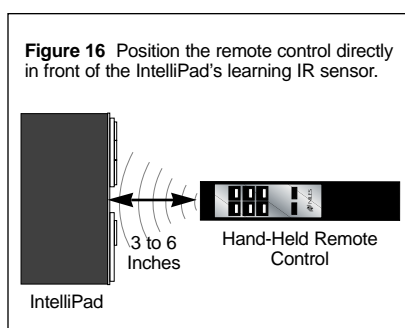
Remote controls issue two kinds of IR commands; single IR commands for normal functions and continuous commands for special functions like Volume Up and Volume Down on a preamp/receiver or Scan Ahead on a VCR. However, some remotes allow you to issue a single IR command continuously by pressing and holding the button on the remote control. IR commands from some manufacturers (e.g. Sony) which are taught to the IntelliPad as continuous commands will not work in sequences. When teaching the IntelliPad, make sure you only press and hold buttons for functions which NEED continuous IR commands:

DO PRESS AND HOLD the buttons of the remote control for at least three seconds when you are teaching the preamp/receiver's Volume Up and Volume Down and when you are teaching VCR or Laser Disc Scan functions.

DO NOT PRESS AND HOLD the buttons on the remote control when you are teaching normal functions (power, stop, play, next track, etc.)

#### Positioning the Hand-Held Remote Control

Different brands and models of remote controls have varying strengths and types of output LEDs. The sensor will not be over or under powered by the remote if it is placed in the recommended position. Aim the remote control



**Figure 16** Position the remote control directly in front of the IntelliPad's learning IR sensor.

directly at the sensor on the IntelliPad, within the operating range of three to six inches in front of the sensor. See **Figure 16**.

### Teaching IR Commands Step-By-Step

#### Programming the Preamp/Receiver Commands into the IntelliPad

1. *Press the PROGRAM button.* The PROGRAM LED, the IR/SEQ LED and the PAGE LED light up red prompting you to select the "page" that you want to teach the IR commands to.
2. *Press the POWER key.* This selects the "System Page" (storage for preamp/receiver commands, i.e. power on, input select, etc.). The KEY LED lights prompting you to select the key that you want to teach the IR commands to.

## WALL MOUNTED PROGRAMMABLE IR KEYPAD SYSTEM

3. *Press the key you want to teach.* For example, you may choose to teach the "Tuner input" first. In this case, you would select the Source Select key labeled "Tuner". The ENT IR LED (Enter IR) lights prompting you to issue the IR command you want the IntelliPad to learn.
  4. *Press the key on the preamp's/receiver's remote control that you would like the IntelliPad to learn.* Hold the remote control between 3 and 6 inches away from the sensor. Aim directly at the IntelliPad's sensor. In our example, you would press the Tuner input select key on the remote control. The KEY LED lights confirming that the IR command has been successfully learned by the IntelliPad.
  5. *Repeat steps 3 and 4 until all of the desired pre-amp/receiver IR commands have been taught to the IntelliPad.*
  6. *Repeat steps 2-5 to program additional source components.*
  7. To exit the Program mode, *press the PROGRAM button twice* (the PROGRAM LED will go out).
- Programming Each of the Source Component Commands Into IntelliPad**
1. *Press the PROGRAM button.* The PROGRAM LED, the IR/SEQ LED and the PAGE LED light up red prompting you to select the "page" that you want to teach the IR commands to. (i.e. CD, Tape, Tuner, etc.)
  2. *Press one of the six Source Select keys.* For example, you may choose to teach the CD page first. In this case, you would press the Source Select key labeled "CD". The KEY LED lights prompting you to select the key you will teach an IR command to.
  3. *Press the key you want to teach.* For example, you may choose to teach the "Play" key first. The ENT IR LED (Enter IR) lights prompting you to issue the IR command you want the IntelliPad to learn.
  4. *Press the key on the CD's remote control that you would like the IntelliPad to learn* (in our example you would press the "Play" key). Hold the remote control between 3 and 6 inches away from the sensor. Aim directly at the IntelliPad's sensor. The KEY LED lights confirming that the IR command has been successfully learned by the IntelliPad.
  5. *Repeat steps 3 and 4 until all of the desired source component (CD in our example) IR commands have been taught to the IntelliPad.*
  6. *Repeat steps 2-5 to program additional source components.*
  7. To exit the Program mode, *press the PROGRAM button twice* (the PROGRAM LED will go out).

**Erasing a Single IR Command**

If you make a mistake, you can erase just a single key anytime by following these steps:

1. Press the PROGRAM button. The PROGRAM LED, the IR/SEQ LED and the PAGE LED light up red.
2. Press and hold the ERASE button until all the PROMPT LEDs light up, then release. The PROGRAM LED begins to flash, warning you that you are about to erase.
3. Select the Page, then the Key that corresponds to the address of the IR command that you wish to erase. This erases any IR code stored at that address.
4. To exit the Program mode, press the PROGRAM button (the PROGRAM LED will go out).

**Building Sequences to Automate Any System**

**Planning the Sequence**

Begin by writing down the address (Page, Key) of the key which will trigger the sequence. Sometimes, it helps to write a note describing the function of the command. A sequence can have a maximum of ten steps. See **Figure 17**.

NOTE: The power command for the preamplifier/receiver is never manually programmed into a sequence. The IntelliPad's Auto Power Insert feature is enabled via the jumper labeled Status Feedback.

NUMBER	PAGE	KEY	NOTES
TRIGGER	<i>System</i>	<i>Tuner</i>	
1	<i>System</i>	<i>Tuner</i>	<i>Tuner Input</i>
2	<i>Tuner</i>	<i>Play</i>	<i>Preset Station</i>
3	<i>Tape</i>	<i>Stop</i>	<i>Tape Deck</i>
4	<i>CD</i>	<i>Pause</i>	<i>CD Player</i>
5			
6			
7			
8			
9			
10			

**Figure 17**  
Planning a sequence

### Programming the Sequence

1. *Press the PROGRAM button.* The PROGRAM LED, the IR/SEQ LED and the PAGE LED light up red.
2. *Press the IR/SEQ key to select Sequence Programming mode.* The IR/SEQ LED lights green, the TRIG LED lights red, while the PAGE LED remains lit.
3. *Select the page on which the key that will trigger the sequence resides.* Select the pages by pressing one of these keys: any of the six SOURCE SELECT keys (the Source Pages), a normal press of the POWER Key (the System Page) or by pressing and holding the Power Key for more than 1 second (the Press and Hold Page). In our example, you would select the System Page by pressing the POWER Key.
4. *Press the key (on the page you just selected) which will trigger the sequence.* In our example, you would select the "Tuner" Source Select key. The TRIG LED turns off confirming that you have selected the trigger key for the sequence. The PAGE LED lights, prompting you to select the page of the first command in the sequence
5. *Select the page of the first command.* In our example, the first command is to select the Tuner input of the receiver. This command is located on the System page which resides under the POWER Key. The KEY LED lights, prompting you to select the key of the first command.
6. *Press the key which issues the first command.* In our example, you would press the TUNER Key (issues the Tuner Input command to the pre-amp/receiver). The PAGE LED lights, prompting you to select the Page of the next command in the sequence.
7. *Repeat steps five and six, until all of the steps in the sequence are programmed.*
8. *Repeat steps 2-7 to program additional source components.*
9. *To exit the Program mode, press the PROGRAM button twice (the PROGRAM LED will go out).*

### Erasing a Sequence

If you make a mistake, you can erase a sequence anytime by following these steps:

1. *Press the PROGRAM button.* The PROGRAM LED, the IR/SEQ LED and the PAGE LED light up red.
2. *Press and hold the ERASE button until the prompt LED's light up, then release.* The PROGRAM LED begins to flash, warning you that you are about to erase.
3. *Press the IR/SEQ button, then the trigger Page key, then the trigger Key.*

### Incorporating Delays

#### Using Delays to Create Scenarios

In a home theater—particularly a theater equipped with many devices like curtains, lifts, screens and lighting—sequences become an art form. For example, you could add a delay to allow a screen to fully drop before the play command is issued. You could allow an IR controlled dimming system to fully dim before engaging a video input. The delays built into the IntelliPad enable you to program sequences that show off your creativity and showmanship.

#### Using Delays to Improve Operation

When you press a Source Select key to turn the system on there is a normal delay of two seconds between the power command and the next command issued by the IntelliPad. This is to accommodate those brands which will not accept another IR command right after turn-on.

Whenever you program a sequence, the normal interval between IR commands is .5 second. Sometimes you will need to add more delay simply to give a particular component time to process the information.

### Incorporating a Delay as a Step in a Sequence

Follow the steps as outlined in the *Programming the Sequence* section located on page 19. When you come to the step that you wish to insert the delay into, do the following:

1. Press the DELAY button when the PAGE LED is lit. All six Source labels will light.
2. Each of the Source Select keys represents a different amount of delay. **See Figure 18.**
3. Press the Source Select key for the amount of time delay you desire (see above chart). The Source labels will unlight and the page LED will be lit so that you can continue your programming sequence.

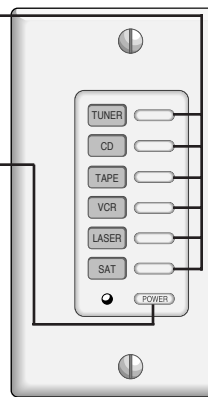
Source 1	.5 Second
Source 2	1 Second
Source 3	2 Seconds
Source 4	4 Seconds
Source 5	8 Seconds
Source 6	16 Seconds

**Figure 18**  
Time delays and their corresponding keys

## WALL MOUNTED PROGRAMMABLE IR KEYPAD SYSTEM

Only the six Source Select keys and the Power key can be programmed to use the Press and Hold feature.

**Figure 19**  
Eligible keys for the Press and Hold feature



Source Select key labeled VCR. The ENT IR LED (Enter IR) lights prompting you to issue the IR command you want the IntelliPad to learn.

4. Press the key on the source component's remote control that you want the IntelliPad to learn. In our example you would press the Power key on the VCR's remote control. The KEY LED lights confirming that the IR command has been successfully learned by the IntelliPad.
5. Repeat steps 3 and 4 to program additional press and hold commands.
6. To exit the Program mode, press the PROGRAM button twice (the PROGRAM LED will go out).

### Programming a Press and Hold Sequence

#### Programming a Press and Hold Single IR Command

1. Press the PROGRAM button. The PROGRAM LED, the IR/SEQ LED and the PAGE LED light up red prompting you to select which "page" the key you wish to teach is located.
2. Press and hold the POWER key. This selects the Press and Hold page (the POWER LED lights up green). The KEY LED lights prompting you to select the key you want to learn a new command.
3. Press one of the Source Select keys or the Power key. In our example, you would press the

1. Follow steps 1-2 in the section *Programming the Sequence* found on page 21.
2. When you are prompted to pick the Trigger Page, press and hold the Power key for more than one second. The status LED lights Red.
3. Press the Source Select key or Power key you want as the trigger key for your press and hold sequence.
4. Follow steps 5-7 in the section *Programming the Sequence* found on page 21.
5. To exit the Program mode, press the PROGRAM button twice (the PROGRAM LED will go out).

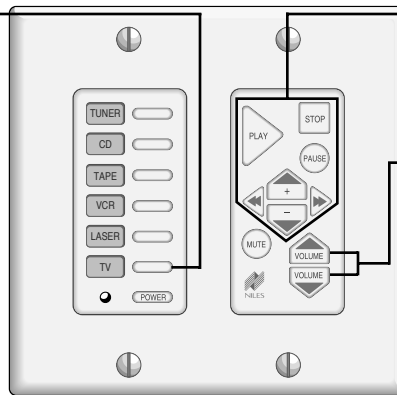
Configuring for a Television that will be used without the Preamp/Receiver.

**TV Source Select Key**

When the Source Select key labeled TV is pressed, the preamp/receiver DOES NOT turn on automatically (Auto Power Insert feature disabled).

A press to any of the other Source Select keys (Auto Power Insert feature enabled) DOES issue the preamp/receiver power command.

This change in operation has been achieved by selectively disabling the IntelliPad's built-in Auto Power Insert feature.



**TV Control Keys**

The TV, like any source, is controlled via the source control keys.

**Volume Keys**

Since the TV is used by itself in this system, the Volume Keys issue only the TV volume up and down when the TV is selected.

When any of the other sources are selected, volume reverts to the pre-amp/receiver's volume up and down.

**Figure 20**  
Configuring for a local television

**Disabling or Enabling the Auto Power Insert For One of the Source Select Keys**

If the local television will be used by itself, it is usually desirable to disable the IntelliPad's automatic insertion of the preamp/receiver "power" command (Auto Power Insert feature) for the TV's Source Select key only. To disable or enable this feature for a particular source do the following:

1. Press and hold the PROGRAM button for more than 2 seconds. Sources that have the feature

"enabled" will light. Sources that have the feature "disabled" will not light.

2. Press the SOURCE SELECT KEY you wish to modify. The source select key will toggle back and forth between enabled and disabled.
3. To exit the Program mode, press the PROGRAM button. The PROGRAM LED will go out.

## Transferring Programs

### Overview

The IntelliPad allows you to transfer programs between two IntelliPads. You must supply power to one of the IntelliPads. The other IntelliPad will get its power via the transfer cable.

### Parts Required

To transfer between IntelliPads you only need the supplied transfer cable and a 12v DC power supply.

### Transferring Programs From One IntelliPad to Another

Follow these steps in order:

1. *Program all the IR commands and sequences on one IntelliPad.*
2. *Test.* Make sure that all codes and sequences work as you desire.
3. *Connect the IntelliPad to 12v DC power.* Use the 12v+ and GND connectors of the IR DATA connector located on the rear of the IntelliPad.
4. *Connect the the Transfer cable to the transfer sockets on both IntelliPads.*

5. *Press the PROGRAM button on both IntelliPads.* The PROGRAM LEDs, IR/SEQ LEDs and PAGE LEDs light on both IntelliPads.

6. *Press the TRANSFER key on both IntelliPads.* The Transfer LED lights on both IntelliPads.

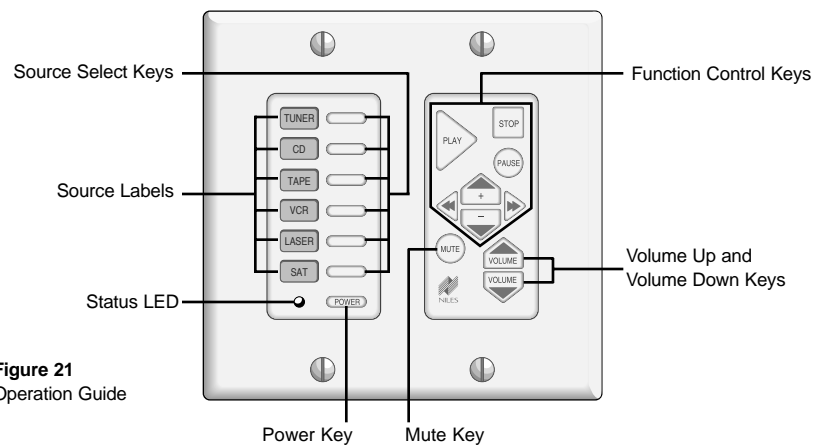
7. *ON THE BLANK INTELLIPAD ONLY, press any key.* The transfer LED blinks on both IntelliPads until the transfer is successfully completed, then both LEDs go out, returning you to normal operation.

## IntelliFile ® PC Storage and Transfer System

The IntelliFile is an optional IntelliPad accessory which enables your Niles dealer to store IntelliPad programmed memory to an IBM or compatible personal computer running Microsoft Windows as the operating system. If needed, the memory files can also be downloaded to an IntelliPad.

The IntelliFile System consists of a storage/transfer program, PC Interface, power supply, and a cable adapter kit.

## WALL MOUNTED PROGRAMMABLE IR KEYPAD SYSTEM



**Figure 21**  
Operation Guide

### Operation

#### A System Using the Status Feedback and Speaker Relay Features

##### Source Select Keys

A single press of a Source Select key can perform five functions. The five functions are:

1. Turn on the preamp/receiver if it is off.
2. Change the input of your preamp/receiver to the selected source.
3. Change the function of the Function Control keys so that they operate the selected source component.
4. Display which source is selected by back-lighting the corresponding source label.
5. Turn on the local speakers (unmute the speaker relay).

## WALL MOUNTED PROGRAMMABLE IR KEYPAD SYSTEM

### Source Labels

The backlit label indicates which source component your Function Control keys will operate.

When the preamp/receiver is off, the label backlighting turns off automatically.

### Status LED

When the preamp/receiver is On, the status LED is lit. The color of the LED displays whether the local speakers are On or Muted.

GREEN

Local speakers and the preamp/receiver are On.

RED

Local speakers are Muted, but the system is On.

OFF

System is Off.

Whenever an IR command is issued to one of your components the LED blinks. It blinks red when green, and green when red.

### Power Key

If the Power key is pressed when the system is On, the preamp/receiver will turn Off.

If the Power key is pressed when the system is Off, the preamp/receiver will turn On, the local speakers will turn On (unmute) and the last source selected will be displayed by the source label.

### Mute Key

This key controls the built-in Speaker Mute feature. You can mute the local speakers anytime by pressing the Mute key. To turn the local speakers back on (or "unmute") you may press either the Mute key or one of the six Source Select keys.

### Volume Up and Volume Down Keys

These keys raise and lower the volume of your preamp/receiver.

### Function Control Keys

A touch to any of the function control keys will operate the selected source component only.

For example, when CD is the selected source, a press on the play key issues the CD's Play IR command. However, when Tape is the selected source, a press of the Play key issues the Tape Deck's Play IR command.

## Troubleshooting

---

**PROBLEM: The IntelliPad Will Not Learn an IR Command**

The IntelliPad will operate most IR controlled components exactly as the original factory remote control did. However, there exists a few brands which operate outside of normal frequencies (23 to 107 kHz). These brands include Bang and Olufsen, Revox, and Pioneer ISC remotes. They cannot be taught to the IntelliPad. In some cases, the manufacturer (i.e. Pioneer) makes a standard frequency remote that will operate the main features of the component. The standard frequency remote can be successfully taught to the IntelliPad. Consult with your Niles dealer about the brand and model in question.

**PROBLEM: One IR Command Does Not Work in a Sequence**

Reteach the IR command to the IntelliPad. Be careful to simply tap the key of the original remote, do not press and hold the key while teaching!

**PROBLEM: Volume Up and Volume Down Do Not Operate Continuously**

The IntelliPad learns most Volume Up and Volume Down commands as continuous codes.

However, some brands have an IR code structure that the IntelliPad interprets as a single code. As a result, you must repeatedly tap the volume up and down keys to make large changes to the volume.

**PROBLEM: One Component Does Not Operate, or Operates Intermittently**

Turn down the level of the flasher. When flasher level is too high, the component's sensor can be overloaded.

**PROBLEM: No Component Operates**

The IntelliPad is only one component in an IR control or repeater system. Problems with connections, optical or electromagnetic interference can prevent an IntelliPad from operating any component. Refer to the troubleshooting guide with your IR main system unit for a step by step guide to troubleshooting an IR control system. Your Niles dealer or professional installer can provide valuable troubleshooting skills.

## WALL MOUNTED PROGRAMMABLE IR KEYPAD SYSTEM

### Specifications

---

#### **IR System**

Compatible with virtually all brands of remote controls using carrier frequencies between 23 and 107 kHz

#### **Wiring Requirements**

##### IR Data and Status

Up to 500' Individual home-runs of 2-conductor shielded cable, West Penn D291 or equivalent

##### Speaker Relay

Individual runs of 2-conductor speaker wire, 14-22 gauge

##### Stand Alone Status Feedback

Up to 200' of 2-conductor wire, 14-16 gauge

##### Local Flasher Output

Up to 200' of 2-conductor wire, 14-16 gauge

#### **Speaker Relay Power Handling**

200 Watts/channel continuous RMS power

#### **FCC Certification**

Class "B" certified for use in a residential environment

#### **Mounting**

In-wall, fits into most 36 cubic. inch double-gang electrical boxes at least 2 3/4" deep, Decora-style faceplate

#### **Unit Dimensions**

3 1/2" wide x 2 9/16" high x 2" deep

#### **Face Plate Dimensions**

Decora wall plate; 4 9/16" wide x 4 1/2" high

#### **Depth Behind Plate**

2 1/2"



Niles Audio  
Corporation

[www.nilesaudio.com](http://www.nilesaudio.com)

12331 S.W. 130 Street  
Miami, Florida 33186  
Tel: (305) 238-4373  
Fax: (305) 238-0185

© 1999 Niles Audio Corporation. All rights reserved. Because Niles constantly strives to improve the quality of its products, Niles reserves the right to change product specifications without notice. Niles, the Niles logo, IntelliPad and IntelliFile are registered trademarks of Niles Audio Corporation. Decora is a registered trademark of Leviton Manufacturing Company. Windows is a registered trademark of Microsoft Corporation. Printed in USA 2/99 DS00154A